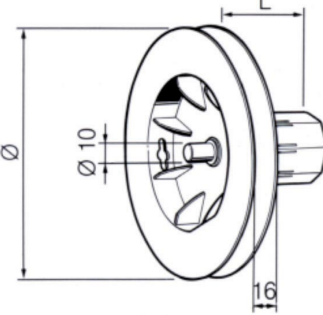
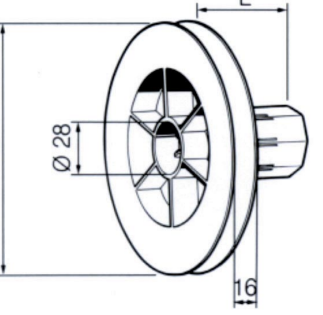
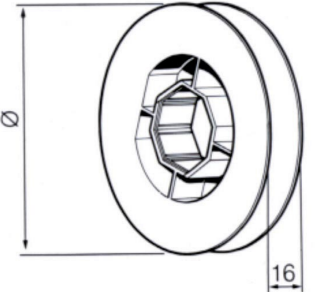
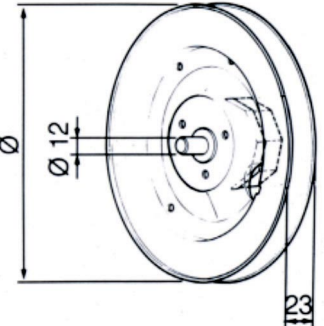
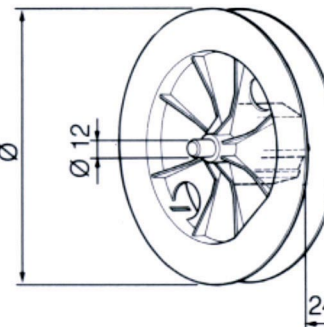
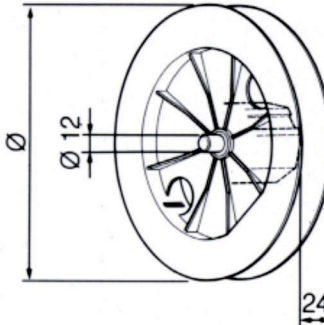
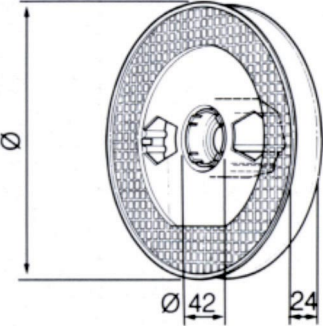
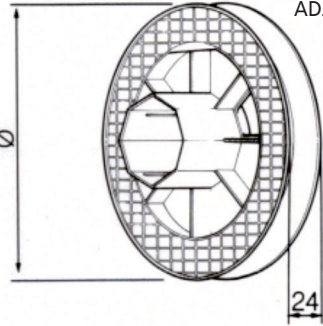
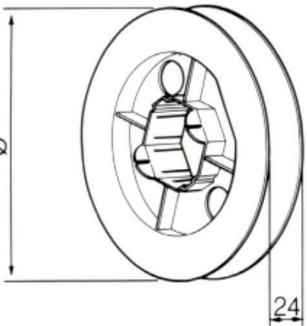
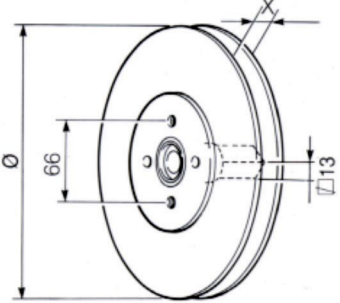
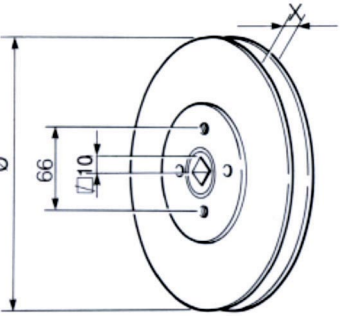

Pulegge e Riduttori
Gurtscheiben und Gurtzuggetriebe
Poulies et Démultiplicateurs
Pulleys and Strap Reduction Gears

Tipo Typ / Type / Type	Codice Art / Ref / Item	Dimensioni (mm) Abmessungen (mm) Dimensions (mm) Dimensions (mm)	Note Anmerkungen / Notes / Notes	per rullo Für Welle Pour axe For reel	Imballo Verpackung Condition Packing
PULEGGIA CON CALOTTA GURTSCHIEBE MIT KAPSEL POULIE AVEC EMBOUT PULLEY WITH CAP 	6D5.3431	Ø 80 L = 38	PLASTICA CON PERNO INTERNO	ott 40 mm	100
	6D5.3441	Ø 100 L = 52	KUNSTSTOFF INNENLIEGENDER STIFT	8kt 40 mm	100
	6D5.3421	Ø 115 L = 52	PLASTIQUE PIVOT INTERNE	oct 40 mm	100
	6D5.3451	Ø 125 L = 38	PLASTIC INSIDE PIVOT		100
	6D5.3461	Ø 140 L = 38			100
	6D5.3471	Ø 155 L = 52			100
	6D5.3481	Ø 170 L = 52			50
PULEGGIA CON CALOTTA GURTSCHIEBE MIT KAPSEL POULIE AVEC EMBOUT PULLEY WITH CAP 	6D5.3531	Ø 80 L = 38	PLASTICA PER CUSCINETTO	ott 40 mm	100
	6D5.3511	Ø 90 L = 38	KUNSTSTOFF FÜR KUGELLAGER	8kt 40 mm	100
	6D5.3541	Ø 100 L = 52	PLASTIQUE POUR ROULEMENT A BILLES	oct 40 mm	100
	6D5.3521	Ø 115 L = 52	PLASTIC FOR BALL BEARING		100
	6D5.3551	Ø 125 L = 38			100
	6D5.3561	Ø 140 L = 38			100
	6D5.3571	Ø 155 L = 52			50
	6D5.3581	Ø 170 L = 52			50
PULEGGIA PER CALOTTA CON CLIPS GURTSCHIEBE FÜR KAPSEL MIT CLIPS POULIE POUR EMBOUT AVEC CLIPS PULLEY FOR CAP WITH CLIPS 	6D5.3811	Ø 90	PLASTICA - PER CALOTTA ART. 6D6.6219	ott 40-60 mm	100
	6D5.3821	Ø 115	ART. 6D6.6213	8kt 40-60 mm	100
	6D5.3851	Ø 125	KUNSTSTOFF - FÜR KAPSEL ART. 6D6.6219	oct 40-60 mm	100
	6D5.3861	Ø 140	ART. 6D6.6213		100
	6D5.3871	Ø 155	PLASTIQUE - POUR EMBOUT REF. 6D6.6219		100
	6D5.3881	Ø 170	REF. 6D6.6213		100
	6D5.3891	Ø 190	PLASTIC - FOR CAP ITEM 6D6.6219	ITEM 6D6.6213	100

Tipo Typ / Type / Type	Codice Art / Ref / Item	Dimensioni (mm) Abmessungen (mm) Dimensions (mm) Dimensions (mm)	Note Anmerkungen / Notes / Notes	per rullo Für Welle Pour axe For reel	Imballo Verpackung Condition Packing
PULEGGIA CON CALOTTA GURTSCHIBE MIT KAPSEL POULIE AVEC EMBOUT PULLEY WITH CAP 	6A5.3353	Ø 180	FERRO ZINCATO - SENZA GANCIO VERZINKTER STAHL - OHNE HAKEN ACIER GALVANISE - SANS CROCHET GALVANIZED STEEL - WITHOUT HOOK	ott 60 mm 8kt 60 mm oct 60 mm oct 60 mm	12
	6A5.3363	Ø 200			12
	6A5.3373	Ø 220			12
	6A5.3383	Ø 240			12
PULEGGIA CON CALOTTA GURTSCHIBE MIT KAPSEL POULIE AVEC EMBOUT PULLEY WITH CAP 	6D5.3743	Ø 160	PLASTICA PERNO A FILO	ott 60 mm 8kt 60 mm oct 60 mm oct 60 mm	10
	6D5.3753	Ø 180	KUNSTSTOFF ANSTEHENDER STIFT		10
	6D5.3763	Ø 200	PLASTIQUE PIVOT A FLEUR		10
	6D5.3773	Ø 220	PLASTIC COUNTERSUNK PIVOT		10
PULEGGIA CON CALOTTA GURTSCHIBE MIT KAPSEL POULIE AVEC EMBOUT PULLEY WITH CAP 	6D5.3772	Ø 220	PLASTICA PERNO INTERNO KUNSTSTOFF INNENLIEGENDER STIFT PLASTIQUE PIVOT INTERNE PLASTIC INSIDE PIVOT	ott 60 mm 8kt 60 mm oct 60 mm oct 60 mm	10

Tipo Typ / Type / Type	Codice Art / Ref / Item	Dimensioni (mm) Abmessungen (mm) Dimensions (mm) Dimensions (mm)	Note Anmerkungen / Notes / Notes	per rullo Für Welle Pour axe For reel	Imballo Verpackung Condition Packing
<p style="text-align: center;"> PULEGGIA CON CALOTTA GURTSCHIEBE MIT KAPSEL POULIE AVEC EMBOUT PULLEY WITH CAP </p> 	<p style="text-align: center;">6D5.3573</p>	<p style="text-align: center;">Ø 220</p>	PLASTICA PER CUSCINETTO Ø 42 MM KUNSTSTOFF FÜR KUGELLAGER Ø 42 MM PLASTIQUE POUR ROULEMENT A BILLES Ø 42 MM PLASTIC FOR BALL BEARING Ø 42 MM	ott 60 mm 8kt 60 mm oct 60 mm oct 60 mm	<p style="text-align: center;">10</p>
<p style="text-align: center;"> PULEGGIA REGOLABILE VERSCHIEBBARE GURTSCHIEBE POULIE REGLABLE ADJUSTABLE PULLEY </p> 	<p style="text-align: center;">6D5.3943</p>	<p style="text-align: center;">Ø 160</p>	PLASTICA KUNSTSTOFF PLASTIQUE PLASTIC	ott 60 mm 8kt 60 mm oct 60 mm oct 60 mm	<p style="text-align: center;">10</p>
	<p style="text-align: center;">6D5.3953</p>	<p style="text-align: center;">Ø 180</p>			<p style="text-align: center;">10</p>
	<p style="text-align: center;">6D5.3963</p>	<p style="text-align: center;">Ø 200</p>			<p style="text-align: center;">10</p>
<p style="text-align: center;"> PULEGGIA «SPECIAL EXPORT» GURTSCHIEBE «SPECIAL EXPORT» POULIE «SPECIAL EXPORT» PULLEY «SPECIAL EXPORT» </p> 	<p style="text-align: center;">6D5.4053</p>	<p style="text-align: center;">Ø 170</p>	PLASTICA - PER CALOTTA ART. 6D6.6833 - 6D6.6733	ott 60 mm 8kt 60 mm oct 60 mm oct 60 mm	<p style="text-align: center;">20</p>
	<p style="text-align: center;">6D5.4063</p>	<p style="text-align: center;">Ø 190</p>	KUNSTSTOFF - FÜR KAPSEL ART. 6D6.6833 - 6D6.6733		<p style="text-align: center;">20</p>
	<p style="text-align: center;">6D5.4073</p>	<p style="text-align: center;">Ø 215</p>	PLASTIQUE - POUR EMBOUT REF. 6D6.6833 - 6D6.6733 PLASTIC - FOR CAP ITEM 6D6.6833 - 6D6.6733		<p style="text-align: center;">20</p>

Tipo Typ / Type / Type	Codice Art / Ref / Item	Dimensioni (mm) Abmessungen (mm) Dimensions (mm) Dimensions (mm)	Note Anmerkungen / Notes / Notes	per rullo Für Welle Pour axe For reel	Imballo Verpackung Condition Packing
MINI-RIDUTTORE 1:2 CON PERNO MINI-GURTZUGGETRIEBE 1:2 MIT STIFT MINI-DEMULTEPLIFICATEUR 1:2 AVEC PIVOT MINI-STRAP REDUCTION GEAR 1:2 WITH PIVOT 	6A2.7909	Ø 125 X = 16			25
	6A2.7910	Ø 140 X = 16			25
	6A2.7911	Ø 155 X = 16			25
	6A2.7912	Ø 170 X = 16			25
	6A2.7913	Ø 180 X = 24			25
MINI-RIDUTTORE 1:2 CON FORO MINI-GURTZUGGETRIEBE 1:2 MINI-DEMULTEPLIFICATEUR 1:2 MINI-STRAP REDUCTION GEAR 1:2 	6A2.7901	Ø 155 X = 16			25
	6A2.7902	Ø 170 X = 16			25
	6A2.7903	Ø 180 X = 24			25

Pulegge e Riduttori
 Gurtscheiben und Gurtzuggetriebe
 Poulies et Démultiplicateurs
 Pulleys and Strap Reduction Gears

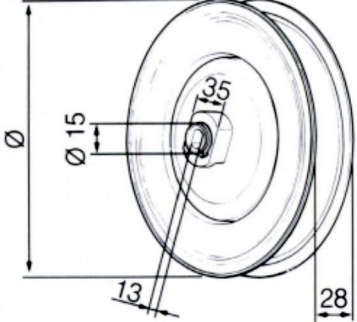
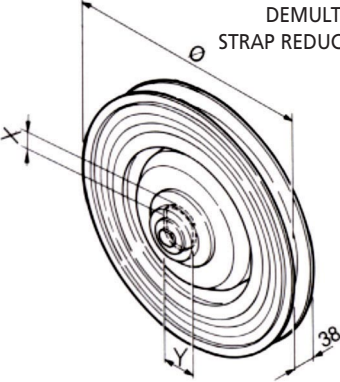
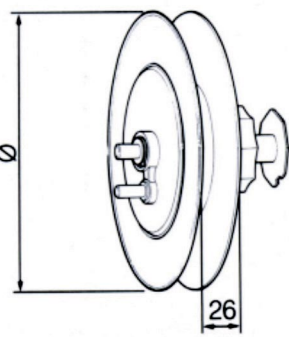
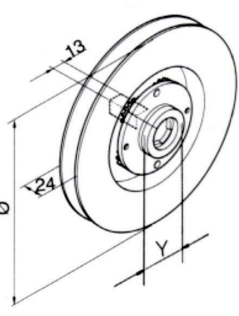

Tipo Typ / Type / Type	Codice Art / Ref / Item	Dimensioni (mm) Abmessungen (mm) Dimensions (mm) Dimensions (mm)	Note Anmerkungen / Notes / Notes	per rullo Für Welle Pour axe For reel	Imballo Verpackung Condition Packing
RIDUTTORE EXPORT GURTZUGGETRIEBE EXPORT DEMULTIPLIFICATEUR EXPORT STRAP REDUCTION GEAR EXPORT 	6A2.7601	Ø 190	RAPPORTO 1:2,6 UNTERSETZUNG 1:2,6 RAPPORT 1:2,6 RATIO 1:2,6		10
	6A2.7602	Ø 210	RAPPORTO 1:2,6 UNTERSETZUNG 1:2,6 RAPPORT 1:2,6 RATIO 1:2,6		10
RIDUTTORE EXPORT GURTZUGGETRIEBE EXPORT DEMULTIPLIFICATEUR EXPORT STRAP REDUCTION GEAR EXPORT 	6A2.7702	Ø 210 X = 11 Y = 30	RAPPORTO 1:2,6 UNTERSETZUNG 1:2,6 RAPPORT 1:2,6 RATIO 1:2,6		10
	6A2.7703	Ø 210 X = 7 Y = 30	RAPPORTO 1:2,6 UNTERSETZUNG 1:2,6 RAPPORT 1:2,6 RATIO 1:2,6		10
	6A2.7704	Ø 210 X = 7 Y = 30	PULEGGIA DECENTRATA VERSETZTE GURTSCHIBE POULIE DEPORTEE DISPLACED PULLEY		10
RIDUTTORE STANDARD GURTZUGGETRIEBE STANDARD DEMULTIPLIFICATEUR STANDARD STRAP REDUCTION GEAR STANDARD 	6A2.7554	Ø 240	RAPPORTO 1:3 UNTERSETZUNG 1:3 RAPPORT 1:3 RATIO 1:3	ott 60 mm 8kt 60 mm oct 60 mm oct 60 mm	10
MINI-RIDUTTORE 1:2 CON PERNO MINI-GURTZUGGETRIEBE 1:2 MIT STIFT MINI-DEMULTIPLIFICATEUR 1:2 AVEC PIVOT MINI-STRAP REDUCTION GEAR 1:2 WITH PIVOT 	6A2.7923	Ø 180 Y = 30			10

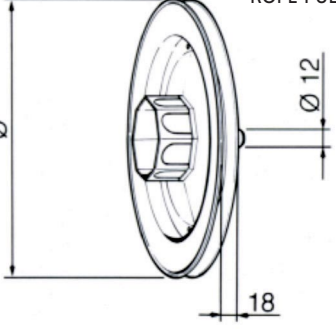
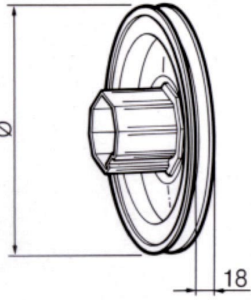
Tipo Typ / Type / Type	Codice Art / Ref / Item	Dimensioni (mm) Abmessungen (mm) Dimensions (mm) Dimensions (mm)	Note Anmerkungen / Notes / Notes	per rullo Für Welle Pour axe For reel	Imballo Verpackung Condition Packing
PULEGGIA PER FUNE CON PERNO SEILSCHEIBE MIT STIFT POULIE A CABLE AVEC PIVOT ROPE PULLEY WITH PIVOT 	6A5.9853	Ø 180	FERRO ZINCATO CON CALOTTA IN FERRO ZINCATO	ott 60 mm 8kt 60 mm oct 60 mm	12
	6A5.9863	Ø 210	VERZINKTER STAHL MIT KAPSEL AUS VERZINKTEM STAHL ACIER GALVANISE AVEC EMBOUT EN ACIER GALVANISE GALVANIZED STEEL WITH GALVANIZED STEEL CAP	ott 60 mm 8kt 60 mm oct 60 mm	12
PULEGGIA PER FUNE CON CUSCINETTO 28 MM SEILSCHEIBE MIT KUGELLAGER 28 MM POULIE A CABLE AVEC ROULEMENT 28 MM ROPE PULLEY WITH BALL BEARING 28 MM 	6A5.7541	Ø 150	FERRO ZINCATO CON CALOTTA IN ALLUMINIO VERZINKTER STAHL MIT ALU-KAPSEL	ott 40 mm 8kt 40 mm oct 40 mm	20
	6A5.7543	Ø 150	ACIER GALVANISE AVEC EMBOUT EN ALUMINIUM GALVANIZED STEEL WITH ALUMINIUM CAP	ott 60 mm 8kt 60 mm oct 60 mm	20
	6A5.7553	Ø 180		ott 60 mm 8kt 60 mm oct 60 mm	20